

McIntosh

OWNER'S MANUAL



C28
SOLID STATE
STEREO PREAMPLIFIER

Price \$1.25

GUARANTEE

McIntosh Laboratory Incorporated guarantees this instrument to be capable of performance as advertised. We also guarantee the mechanical and electrical workmanship and components to be free of defects for a period of 90 days from date of purchase. If such defects occur, McIntosh Laboratory or one of its authorized agencies will repair the defect at no cost to the purchaser. This guarantee does not extend to components damaged by improper use nor does it extend to transportation to and from the factory or service agency.

THREE YEAR FACTORY SERVICE CONTRACT

An application for a FREE THREE YEAR FACTORY SERVICE CONTRACT is included with this manual. The terms of the contract are:

For Three Years from date of purchase

1. McIntosh will provide all parts, materials and labor needed to return the measured performance of the instrument to the original factory specifications free of any charge. The SERVICE CONTRACT does not cover any shipping costs to and from the authorized service agency or the factory.
2. Any McIntosh authorized service agency will repair all McIntosh Instruments at normal service rates. To receive the free service under the terms of the SERVICE CONTRACT, the SERVICE CONTRACT CERTIFICATE must accompany the instrument when taken to the service agency.
3. Always have service done by a McIntosh authorized service agency. If the instrument is modified or damaged as a result of unauthorized repair the SERVICE CONTRACT will be cancelled.
4. The SERVICE CONTRACT is issued to you as the original purchaser. To protect you from misrepresentation this contract cannot be transferred to a second owner.
5. The SERVICE CONTRACT is given to the purchasers who live in the 50 United States or Canada only.
6. For your protection McIntosh selects its dealers carefully- The requirements are very strict. Only one dealer in seven applicants qualifies for a McIntosh franchise. To receive the SERVICE CONTRACT your purchase must be made from a McIntosh franchised dealer.
7. Your completely filled in application for a SERVICE CONTRACT must be postmarked within 30 days of the date of purchase of the instrument.
8. To receive the SERVICE CONTRACT all information on the application must be filled in. The SERVICE CONTRACT will be issued when the completely filled in application is received at McIntosh Laboratory Incorporated in Binghamton, New York. If the application is not received at McIntosh Laboratory, only the service offered under the 90-day guarantee will apply.

CONTENTS

Guarantee
 Installation. 2-3
 If You're In A Hurry. 4
 How To Connect 5-8
 Adjusting The Top Panel Controls ... 9
 Using The Front Panel Controls 10, 11
 Using The Pushbuttons. 12, 13
 Specifications. 14, 15
 Performance Charts. 16, 17
 Technical Description. 18, 19
 Block Diagram. 20

Your C 28 stereo preamplifier will give you many years of pleasant and satisfactory performance. If you have any questions concerning operation or maintenance please contact the dealer from whom you purchased this instrument or:—

CUSTOMER SERVICE

McIntosh Laboratory Inc.
2 Chambers Street
Binghamton, New York 13903
Our telephone number is 607-723-3512

**TAKE ADVANTAGE OF 3 YEARS OF FREE FACTORY SERVICE
FILL IN THE APPLICATION NOW!**

**C 28
SOLID STATE
STEREO PREAMPLIFIER**

Installation

Adequate ventilation extends the trouble-free life of electronic instruments. It is generally found that each 10° centigrade (18° F) rise in temperature reduces the life of electrical insulation by one half. Adequate ventilation is an inexpensive and effective means of preventing insulation breakdown due to unnecessarily high operating temperature. The direct benefit of adequate ventilation is longer, trouble-free life.

The suggested minimum space for mounting the C 28 is 15 inches deep x 17½ wide x 6 inches high. It can be mounted either horizontally or vertically.

To prepare the C 28 for installation remove the plastic protective covering. Turn the C 28 upside down so that it rests on its top on the shipping pallet. Remove the four plastic feet fastened to the bottom of the chassis.

Next place the mounting brackets, the parts bag and the mounting template for easy accessibility.

The professional mounting design eliminates the need for you to provide any shelf or bracket to support the C 28. It is completely supported by its own mounting brackets.



Position the plastic mounting template over the area of the panel to be cut out for installation.

The design of the mounting template allows you to position or locate the cutout from the front or rear of the panel to which the instrument is to be mounted.

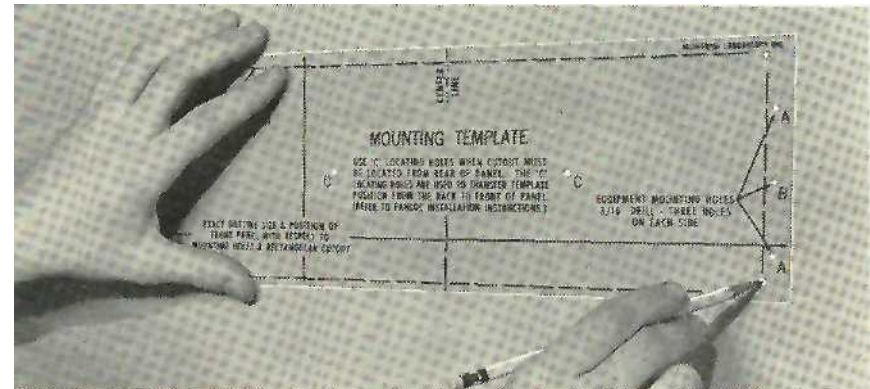

If the cutout is to be located from the rear of the panel, the following steps will help you:

On the back of the cabinet panel, scribe a vertical centerline through the exact center of the area in which the cutout is to be made.

Place the template against the back of the panel and match the template centerline with the centerline on the cabinet panel. Make sure that there is at least ¼ inch clearance between the bottom of the dashed line of the cutout area on the template and any shelf or brace below the proposed cutout.

Mark the two locating holes ("C" holes on the mounting template).

Drill the two locating holes. Be certain the drill is perpendicular to the panel.

Now position the template on the front of the panel by aligning the "C" locating holes on the template with the drill holes.

With the template in place against the cabinet panel, mark the "A" and "B" drill holes and the four small holes that identify the corners of the cutout. Join the corner marks with a pencil. The edge of the template can be used as a straight edge.

IMPORTANT: DRILL THE 6 HOLES BEFORE MAKING THE CUT-OUT.

Accurately drill each of the three holes on the left and the right side of the cutout area with a 3/16 inch drill.

With the saw on the **INSIDE OF THE PENCIL LINES** carefully cut out the rectangular opening.

Secure the mounting strips to the rear of the cabinet panel using two screws from the hardware package.

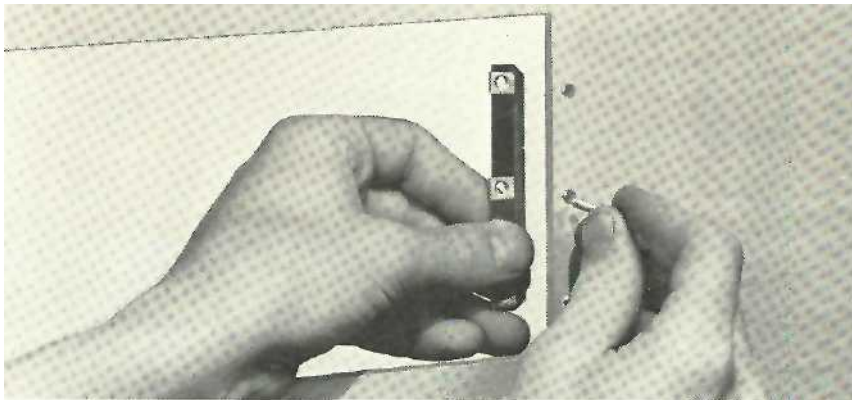

Insert the screws in the center holes of the cabinet panel {"B" holes on the template) and tighten. The screw head should pull into the wood slightly. (Use two 3/4 inch long screws for panels under 1/2 inch, or two VA inch long screws for panels 1/2 inch or thicker.)

Attach the mounting brackets to the cabinet panel using four screws.

Place the template over the mounting screws. The mounting screws should be centered in the "A" and "B" holes on the tem-

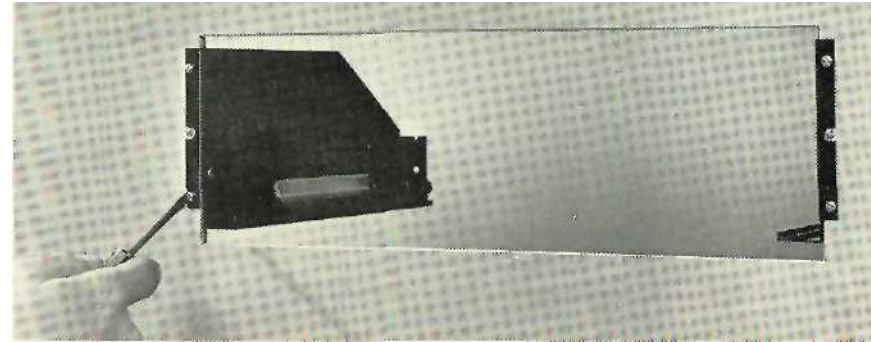

plate. The sides of the mounting brackets should match the vertical dash lines on the template. If necessary, loosen the screws and push the brackets into alignment and retighten.

Insert the power cord through the opening so the rails on the bottom of the equipment slide in the track of the mounting brackets. Continue to slide the instrument in until the front panel is against the cabinet panel.

At the bottom front corners of the PANLOC instruments are the PANLOC buttons.

Depressing the PANLOC buttons will lock the instrument firmly in the installation.

Depressing the PANLOC buttons a second time (as with a ball-point pen) will release the instrument. You can then slide the instrument forward to the inspection-adjustment position.

Depressing the inspection-adjustment position latches will allow the instrument to slide completely out of the installation.

VERTICAL INSTALLATION

In the hardware packet are two helical springs. Fasten the springs to the small flanges at the rear of the PANLOC brackets. The flange has a notch and a hole to mount the spring. The springs assist in the removal of vertically mounted PANLOC equipment.

DO NOT USE THE SPRINGS ON HORIZONTALLY MOUNTED EQUIPMENT.

If You're In A Hurry

A-BALANCE (outer ring)——make one speaker louder than the other. Permits the adjustment for unequal sound caused by room acoustics or program material.

B-COMP center knob) . . three position switch. FLAT is the center position. PRES (the left of center position) increases the mid-frequencies. LOUD (the right of center position) adjusts frequency response as volume is reduced to compensate for hearing losses at low volumes.

C-INPUT SELECTOR

AUX ... for any device connected to the AUX inputs on back.

TUNER ... for FM stereo or AM/FM tuner.

PHONO 1 ... for record player.

PHONO 2 ... for record player.

MIC ... for microphone.

TAPE HD ... for tape deck without electronics.

D-MODE SELECTOR

Use the STEREO or STEREO REVERSE positions for all stereo programs. All other positions are designed to handle monophonic programs.

E-VOLUME ON/OFF

Turns the AC to the C 28 on, adjusts loudness of sound to suit your taste.

F-BASS

Modify the low frequency program material to suit your taste. Right channel is the right knob, the left channel is the left knob.

G-TREBLE

Modify the high frequency program material to suit your taste. Right channel is the right knob, the left channel is the left knob.

H-PUSHBUTTONS

TAPE 1; Push in - Monitor the recorded program on TAPE recorder 1; Out-Hear the program being recorded on TAPE recorder

TAPE 2: Push in - Monitor the recorded program on TAPE recorder 2; Out-Hear the program being recorded on TAPE recorder 2.

MUST BE IN OUT POSITION TO HEAR ANY OTHER PROGRAM SOURCE.

I - 1→2/2→1 ... copy from TAPE 1 to TAPE 2 or from TAPE 2 to TAPE 1, when two tape recorders are used.

J- LF ... FILTER in ... reduces low frequency noise such as turntable rumble, OUT - flat response.

K-HF... FILTER in ... reduces high fre-

quency noise such as record surface noise, OUT- flat response.

L-MAIN (must be used with the accessory SCR). Turns the main loudspeaker on or off.

M-REMOTE (must be used with the accessory SCR). Turns the remote loudspeaker on or off.

N- JACKS

TAPE INPUT

For use as another tape recorder input. Uses the functions normally connected to TAPE 2.

O-TAPE OUTPUT

For use as another tape recorder output. Uses the functions normally connected to TAPE 2.

P-HEADPHONE ... to connect a set of stereo headphones.

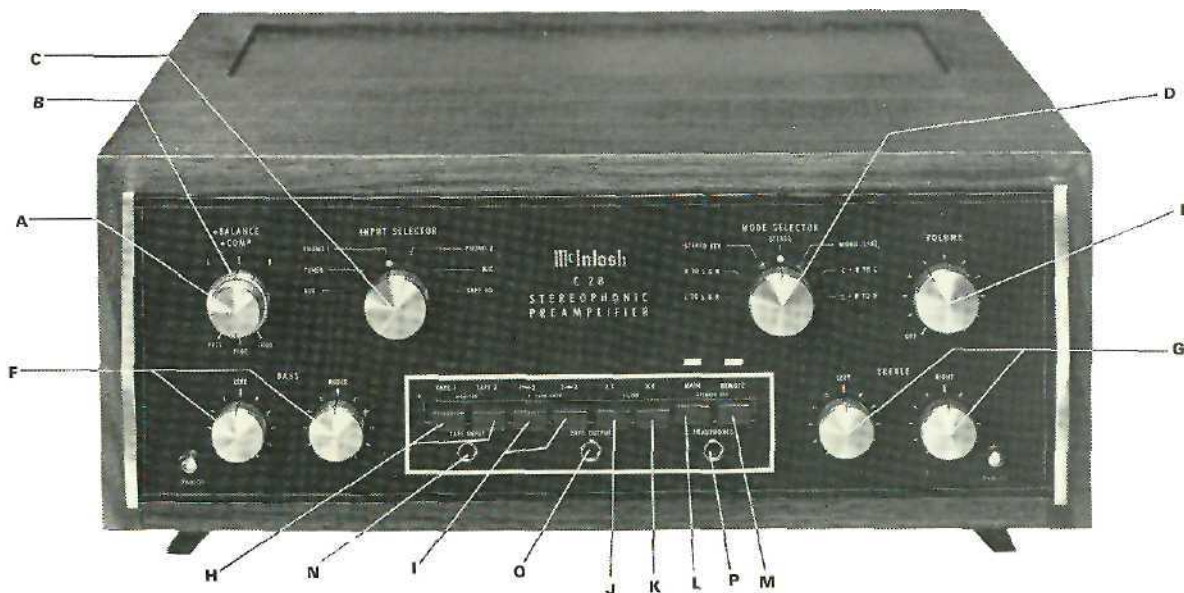

How To Connect



CONNECTING A RECORD PLAYER TO PHONO 1

Connect the cable from the "left" channel of the record player into the "L" PHONO 1 input jack.

Connect the cable from the "right" channel of the record player into the "R" PHONO 1 jack.

PHONO 2 is provided for the use of a second record player.

Connect the cable from the "left" channel of the record player into the "L" PHONO 2 input jack.

Connect the cable from the "right" channel of the record player into the "R" PHONO 2 input jack.

CONNECTING A MICROPHONE

Connect the cable from the "left" microphone to the "L" MIC input jack. Connect the cable from the "right" microphone to the "R" MIC input jack.

CONNECTING A TAPE DECK FOR PLAYBACK

Connect the cable from the "left" tape recorder head on the tape deck (one without its own electronics) to the "L" TAPE HEAD input. Connect the cable from the "right" tape recorder head to the "R" TAPE HEAD input.

CONNECTING A STEREO TUNER

Connect the cable from the "left" channel tuner output to the "L" tuner input jack.

Connect the cable from the "right" channel tuner output to the "R" TUNER jack.

AUX

Any high level program source such as another tuner or a TV set can be connected to the input jacks marked "AUX."

CONNECTING A TAPE RECORDER

To Record:

Connect a cable from the "L" TAPE OUTPUT jack marked TAPE 1 to the "left" high level input of a tape recorder.

Connect a cable from the "R" TAPE OUTPUT jack marked TAPE 1 to the "right" high level input of the tape recorder.

Connect a second tape recorder in the same fashion to the TAPE 2 outputs.

To Playback/Monitor:

Connect the cable from the "left" channel output of a tape recorder to the high level inputs . . . "L" TAPE 1.

Connect the cable from the "right" channel output of a tape recorder to the high level input .. "R" TAPE.

Connect a second tape recorder in the same fashion to the TAPE 2 input jacks.

How To Connect

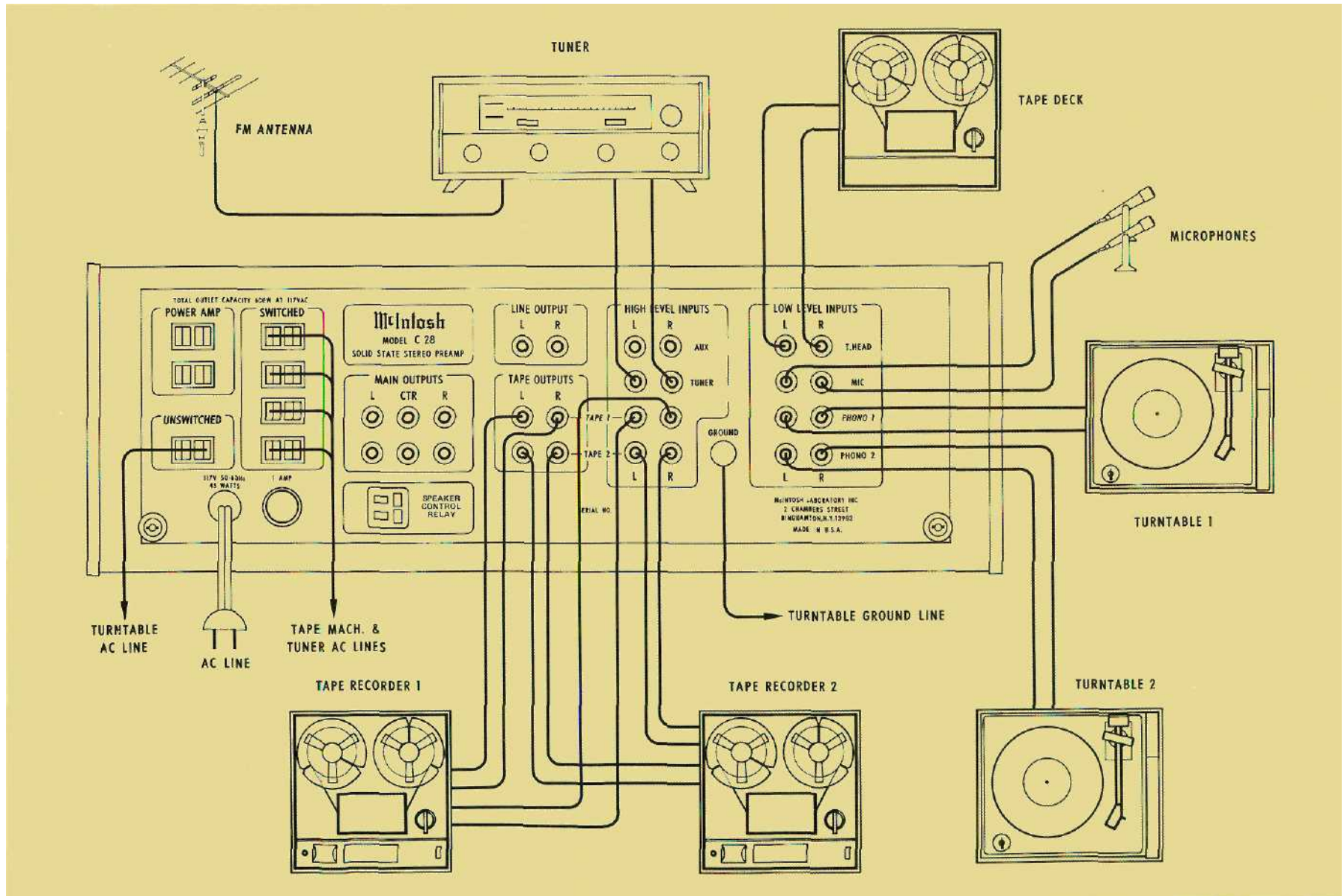

How To Connect

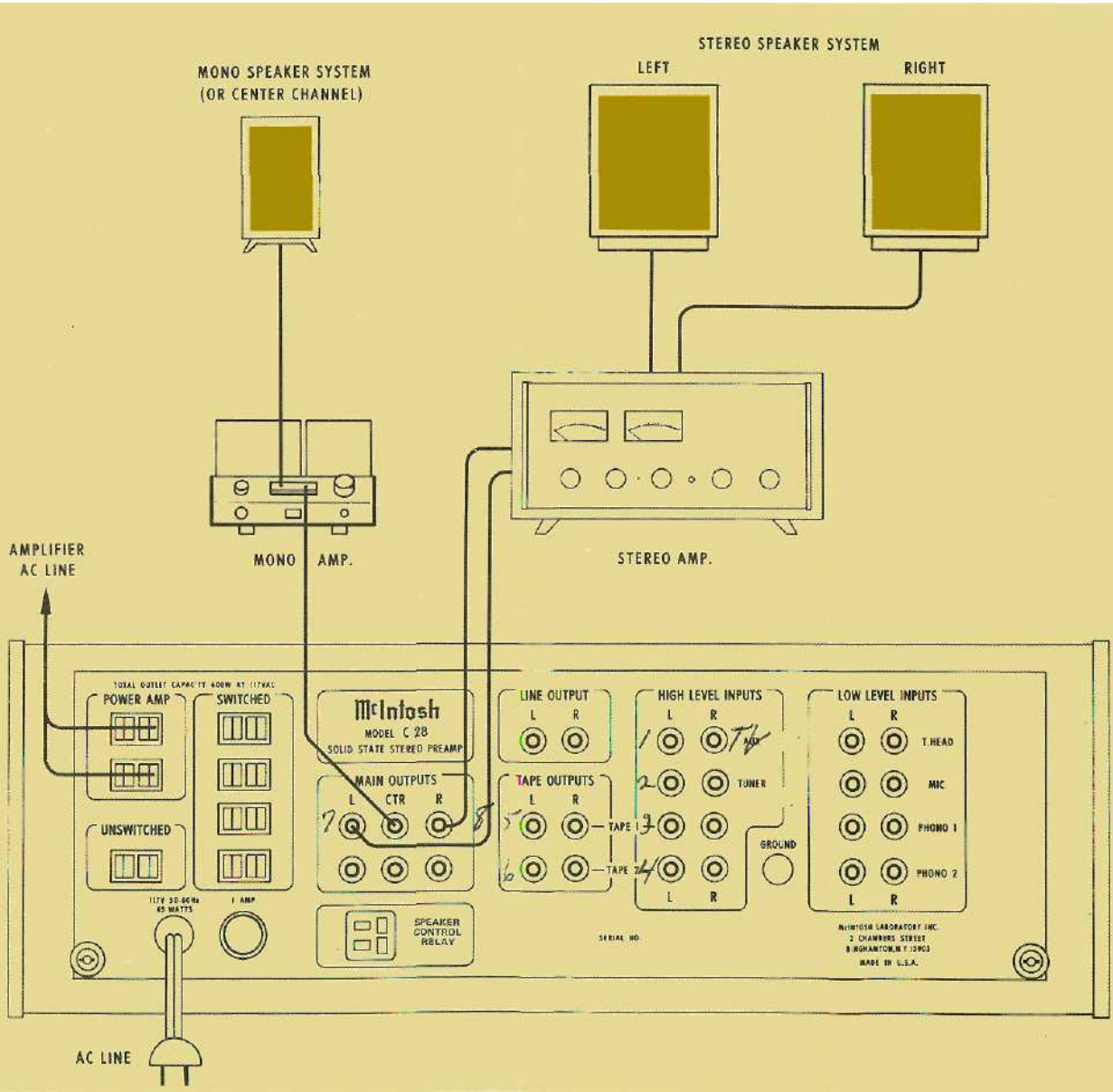

CONNECTING THE C 28 TO POWER AMPLIFIERS

Connect the MAIN output jacks to the input of a stereo power amplifier. The "L" jack is connected to the "left" amplifier input jack. The "R" jack is connected to the "right" amplifier input jack.

The output impedance at the MAIN output is 100 ohms. Longer cables than are supplied can be connected between the C 28 and the amplifiers. The length of the cable is limited by the capacity of the cable. The total capacity must not exceed 1000 pF. For instance: cables with a capacity of 25 pF per foot may be 40 feet long. 13.5 pF per foot cable may be 75 feet long. The input impedance of the amplifiers should be 47,000 ohms or greater.

CTR Output:

Use the CTR output to feed left plus right signal to a separate power amplifier for monophonic background music or for a center channel speaker.

SPEAKER CONTROL RELAY

To control main and remote loudspeakers from the front panel of the C 28 an accessory McIntosh SCR control is needed. Plug the cable from the SCR control into the SPEAKER CONTROL RELAY receptacle. The speakers are then connected to the SCR control. (See Diagram p.8)

AC OUTLETS

There are 4 black AC outlets, 2 green AC outlets, and one red AC outlet. The power to the black AC outlets is controlled by the front panel switch. Use these outlets for a tuner, tape recorder, etc. The green outlets are controlled by the top panel switch marked "Power Amplifier." The red receptacle is on at all times. Use the red outlet for a turntable or record changer. The turntable is protected by this arrangement. It is necessary to turn off the turntable or record changer with its own AC switch.

GROUND CONNECTION

A single ground post is provided. Grounds for turntables, record changers, tape decks, etc. should be connected to this post. The left and right program cables and the ground wire from that source should be wound or twisted together. To avoid hum, make sure the ground wire does not make any connections to the shields of the left and right program cables between the program source and the C 28.

How To Connect

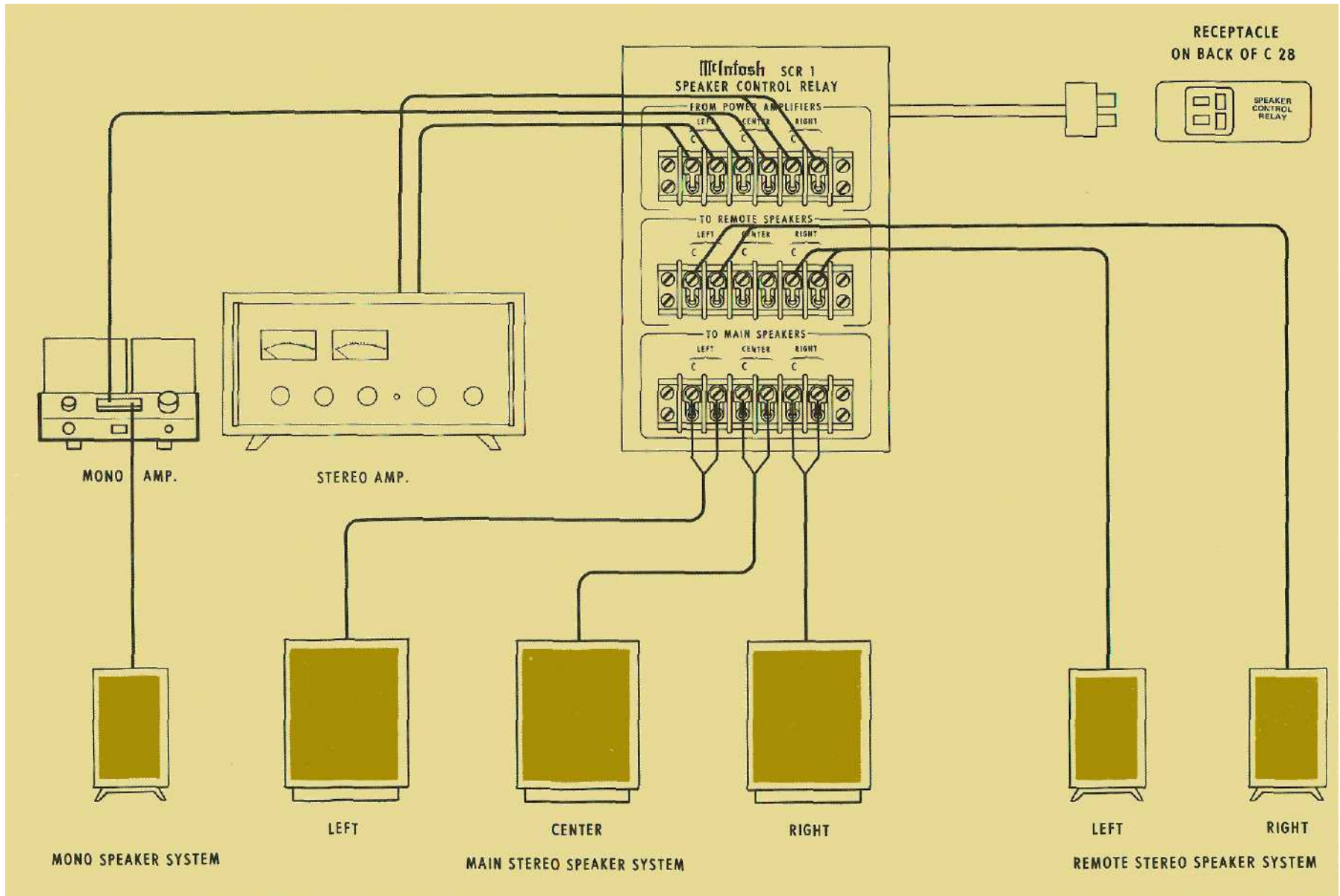

Adjusting The Top Panel Controls

You will enjoy the best in stereo performance more when the stereo system is properly balanced. For proper balance each channel must be equal in loudness and similar in frequency response. Use the top panel LEVEL controls to balance system loudness and the top panel BASS TRIM controls to balance for frequency response differences at low frequencies.

Do not use the front panel BALANCE control to correct for system unbalance. The BALANCE control is used to adjust for any unbalance in the source material, the record, etc.

Before attempting to balance the output of the C 28 make certain the front panel controls are set properly.

Turn the VOLUME control to the OFF (totally counter-clockwise) position.

Set the MODE SELECTOR to STEREO and the BALANCE control at the center or 12 o'clock position. Turn the tone controls to the center or 12 o'clock position. The HF and LF pushbuttons should be in the out position and the COMPENSATION control in the flat position. Turn the INPUT SELECTOR to TUNER.

Depress the PANLOC buttons and pull the preamplifier out to the adjust position. The controls on the top panel are now easily adjusted.

On the top panel turn the BASS TRIM controls counter-clockwise. Turn all the level controls to the clockwise position. Turn the POWER AMPLIFIER switch on.

With the tuner turned on, turn up the VOLUME control on the front panel until a comfortable room loudness is reached.

Then switch the INPUT SELECTOR to PHONO 1, the MODE SELECTOR to L TO L & R, use a monophonic record and turn down the top panel LEFT PHONO 1 LEVEL control to match the loudness of the tuner. Repeat the procedure with the RIGHT PHONO 1 LEVEL control. When the channels are equally loud the system is balanced for loudness.

Repeat the same steps for PHONO 2.

Bass Trim:

A control has been provided in each channel that adjusts the bass loudness. These controls are used to compensate for the differences in loudspeaker response at low frequencies or for the

room in which they are used. They are variable controls that provide up to 6 dB of boost below 100 Hz. With the control in the counter-clockwise position the response is flat. Clockwise rotation increases the bass loudness. Adjust one channel at a time.

Headphone Level:

A control has been provided in each channel to adjust the loudness of the program when using headphones. The controls adjust the output in each channel to the HEADPHONE jack only and do not affect the program loudness from the loudspeakers. To adjust for comfortable headphone listening first adjust the VOLUME control on the front panel to normal room loudness. Then, while wearing the headphones, adjust the HEADPHONE LEVEL control to the desired loudness level.

Output Level:

A control has been provided in each channel that adjusts the output of the preamplifier. Use these controls to compensate for minor differences in loudspeaker efficiency or amplifier gain. These controls adjust the level to the MAIN OUTPUTS only.

With the MODE SELECTOR in the MONO (L + R) position set the BALANCE control to 12 o'clock. Adjust the top panel OUTPUT LEVEL controls until the loudness from each loudspeaker is equal.

Center Channel Level:

A control has been provided that adjusts the combined left plus right program level to the CTR output jacks.

Power Amplifier On/Off:

A switch has been provided that will control the AC power to the green POWER AMPLIFIER receptacles independently of the C 28 front panel control. Use this switch to turn off the amplifier when listening to the headphones, etc.

IMPORTANT: TO HEAR THE PROGRAM FROM THE LOUDSPEAKERS THIS SWITCH MUST BE IN THE ON POSITION.

McIntosh C28

Using The Front Panel Controls

In the upper left of the front panel is a concentric control. The large outer knob is the BALANCE control. The small center knob is the COMPENSATION control.

BALANCE:

The BALANCE control adjusts for unequal loudness in either the left or right channels. The loudness of the channels can be varied relative to each other without affecting their combined loudness.

Left . . . turning the control to the left accents the left channel by reducing the right channel output.

Right . . . turning the control to the right accents the right channel by reducing the left channel output,

COMPENSATION:

The COMPENSATION control is a three position switch.

Pres: In the left of center position the response of the C 28 is shaped to emphasize the upper mid-frequencies.

Flat: In the center position the response of the C 28 is unmodified.

Loud: When the volume is reduced, the music will seem to lose much of its bass and some of its treble. This effect is due to the sensitivity characteristic of human hearing. The response of the human ear to bass and treble pitch decreases more rapidly than its response to notes centered in the mid-tonal range as sound intensity is reduced. The LOUD control automatically provides the correct amount of equalization required to compensate for the change in response of the human ear at low loudness levels. When the switch is in the LOUD position, it converts the volume control to a loudness compensated control. Use the LOUD position to listen at low volume and still hear full-frequency range.

INPUT SELECTOR:

Aux: Connects the output from any high level program source requiring flat amplification to the high level input stage. Such a source could be a television set. In the AUX position the gain is 20 dB to the MAIN outputs, 0 dB to the TAPE outputs, and 17.5 dB to the LINE outputs. The input impedance is 250,000 ohms.

Tuner: Connects the output from any AM, FM or MPX FM tuner to the high level input stage. In the TUNER position the C 28 has flat amplification. There is 20 dB of gain to the MAIN outputs, 0 dB to the TAPE outputs and 17.5 dB to the LINE outputs. The input impedance is 250,000 ohms.

Phono 1: Connects the output of any magnetic phono cartridge to the low level input stage. The response has been shaped to compensate for the characteristics of the magnetic phono cartridge. The gain at 1 kHz is 62 dB to the MAIN outputs, 42 dB to the TAPE outputs and 59.5 dB to the LINE outputs. The input impedance is 47,000 ohms.

Phono 2: Same as PHONO 1.

Mic: Connects the output of any high impedance microphone to the low level input stage. In the MIC position the C 28 has flat amplification. The gain is 60 dB to the MAIN outputs, 40 dB to the TAPE outputs and 57.5 dB to the LINE outputs. The input impedance is 500,000 ohms.

Tape Hd: Connects the output of any tape head (a tape deck without its own electronics) to the low level input stages. The response has been shaped to compensate for the characteristics of the tape head. The gain at 500 Hz is 64 dB to the MAIN outputs, 44 dB to the TAPE outputs and 61.5 dB to the LINE outputs. The input impedance is 500,000 ohms.

MODE SELECTOR: Connects the program to the loudspeaker in the following seven ways:

L to L & R: Connects the "left" input to both loudspeakers.

R to L & R: Connects the "right" input to both loudspeakers.

Stereo Rev: Connects the "left" input to the "right" loudspeaker and the "right" input to the "left" loudspeaker.

Stereo: Connects the "left" input to the "left" loudspeaker and the "right" input to the "right" loudspeaker.

Mono (L + R): adds the "left" input and the "right" input and then connects the L + R program to both amplifiers and loudspeakers.

L + R to L: Connects the "left plus right" program to the "left" loudspeaker only.

L + R to R: Connects the "left plus right" program to the "right" loudspeaker only.



VOLUME ON/OFF:

Turning the VOLUME totally counter-clockwise turns the C 28 OFF. The VOLUME control regulates the loudness in both channels. The VOLUME control has been precision tracked throughout the listening range (0 to -65 dB) for accurate stereo balance.

BASS:

The C 28 has separate 11 position tone control switches in each channel for bass and treble.

Left: Adjusts the bass loudness from the left loudspeaker. Clockwise rotation increases the bass loudness while counter-clockwise rotation decreases the bass loudness. Each step of the tone control adjusts the bass loudness 4 dB.

Right: Has the same effect on the sound from the right loudspeaker.

TREBLE:

Left: Adjusts the treble loudness from the left loudspeaker. Clockwise rotation increases the treble loudness while counter-clockwise rotation decreases the treble loudness. Each step of the tone control adjusts the treble loudness about 4 dB.

Right: Has the same effect on the sound from the right loudspeaker.

PANLOC:

McIntosh developed PANLOC mounting brings professional installation technique to stereo. Depressing the PANLOC buttons (as with a ball point pen) will release the instrument. It can then be pulled toward you to the "adjustment" position. In this position the top panel controls can be adjusted.

Using The Pushbuttons

The C 28 is designed to be used with one, two or three tape recorders, for example — tape playback from a tape deck (one without its own electronics) and, in addition, two complete tape recorders. The front panel pushbuttons control the latter. The pushbuttons permit normal playback of either recorder, monitor of either recorder as recordings are being made, or copying tapes from one recorder to another while listening to a separate program.

TAPE 1

PUSHBUTTON OUT . . . The program source is fed to the power amplifiers and heard through the loudspeakers.

IN . . . The program source becomes the recorded tape on the tape recorder connected to TAPE INPUT 1. The recorded program from tape recorder 1 is fed to the power amplifiers and heard from the loudspeakers.

With the pushbuttons in the monitor position a rectangle is lighted in RED above the pushbutton. When the RED light is on only the tape can be heard. To listen to other sources the pushbutton must be out and the light off.

TAPE 2

The second complete tape recorder can be operated in the same fashion.

TAPE 2 pushbutton also controls the program from a tape recorder plugged into the front panel jacks marked TAPE INPUT and TAPE OUTPUT. When a tape recorder is plugged into the front panel jacks all the facilities for TAPE 2 are automatically switched to the front panel jacks. A tape recorder plugged into the TAPE 2 INPUTS and OUTPUTS on the back panel is automatically disconnected.

Use the front panel pushbutton TAPE 2 to record on or playback from a tape recorder plugged into the front panel jacks.

TAPE COPY 1 - 2

This pushbutton, when pushed IN, connects the TAPE 1 INPUT jacks to the TAPE 2 OUTPUT jacks without affecting the program being heard from the speakers. In this position a copy of the program on tape recorder 1 can be made on tape recorder 2. With the pushbutton IN a rectangle is lighted in ORANGE above the pushbutton.

To monitor the tape copy procedures use the TAPE 1 MONITOR pushbutton.

TAPE COPY 2 - 1

This pushbutton, when pushed IN, connects the TAPE 2 INPUT jacks to the TAPE 1 OUTPUT jacks without affecting the program heard from the speakers. In this position a copy of the program on tape recorder 2 can be made on tape recorder 1. With the pushbutton in the IN position a rectangle is lighted in ORANGE above the pushbutton.

To monitor the tape copy procedures use the TAPE 2 MONITOR pushbutton.

L. F. (LOW FREQUENCY FILTER)

Use the L. F. filter switch to reduce objectionable low-frequency noise created by a turntable or record changer or acoustically coupled feedback.

OUT . . . filter disconnected

IN . . . low-frequency rumble and noise below 50 Hz are reduced when the switch is pushed to the IN position.

With the LF pushbutton in the IN position a rectangle is lighted in GREEN above the pushbutton. When the GREEN light is on the low frequency filter is in operation.

H. F. (HIGH FREQUENCY FILTER)

Use the H. F. filter switch to reduce objectionable high-frequency noise such as record scratch.

OUT . . . filter disconnect

IN . . . rolls off response sharply at 7 kHz.

With the H. F. pushbutton in the IN position a rectangle is lighted in GREEN above the pushbutton. When the GREEN light is on the high frequency filter is in operation.

SPEAKER PUSHBUTTONS

Speakers can be turned on and off when properly connected with the accessory McIntosh SCR control. (See diagram Pg. 8)

If the program is to be heard from the main speakers only, the REMOTE pushbutton is pushed IN. This turns off the remote speakers and lights a rectangle in BLUE above the pushbutton. The BLUE light indicates that the remote speakers are off and no program can be heard from them.

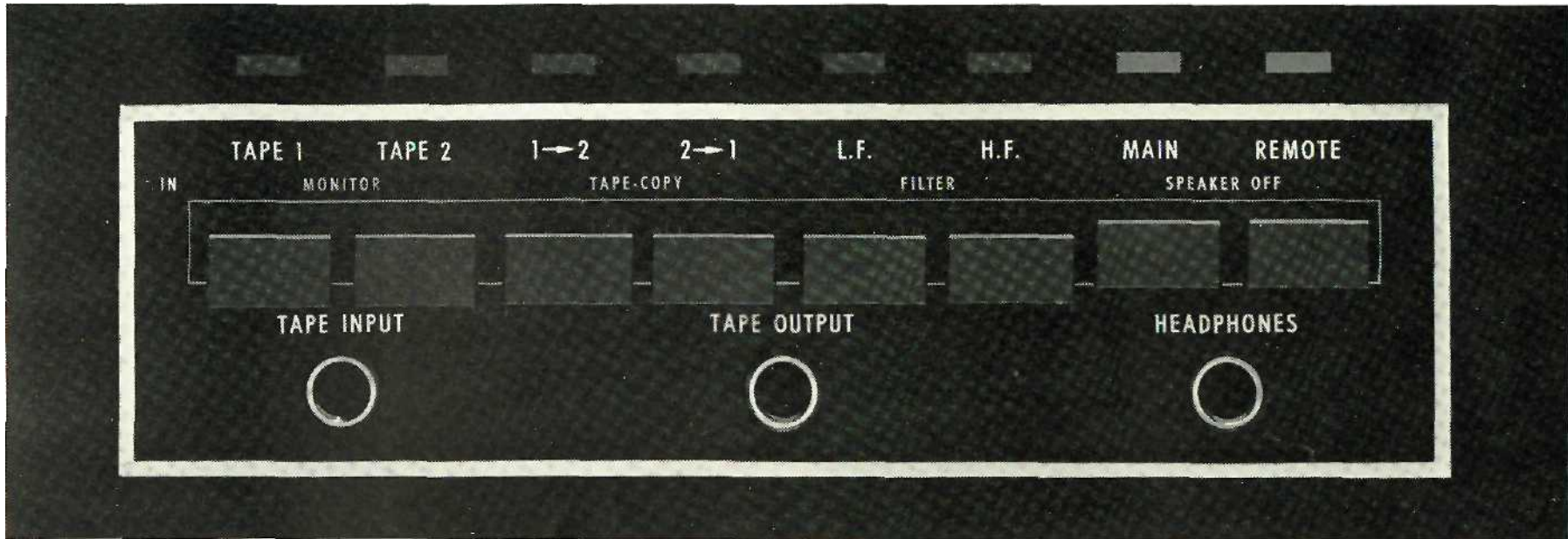

If the program is to be heard from the remote speakers only the MAIN pushbutton is pushed IN. This turns off the main speakers and lights a rectangle in BLUE above the pushbutton. The BLUE light indicates that the main speakers are off and no program can be heard from them.

To hear program from both main and remote speakers, both the MAIN and REMOTE pushbuttons must be out and the BLUE lights must be off.

FRONT PANEL JACKS:

TAPES INPUT - TAPES OUTPUT

When a tape recorder is plugged into the front panel jacks all the facilities for TAPES 2 are automatically switched to the front panel jacks. A tape recorder plugged into the TAPES 2 INPUTS and OUTPUTS on the back panel is automatically disconnected.

Use the front panel pushbutton TAPES 2 to record or playback

from a tape recorder plugged into the front panel jacks.

HEADPHONES:

Plug headphones into the front panel HEADPHONE jack. Adjust the front panel VOLUME control for comfortable headphone listening. {See Pg. 9 }

An amplifier in the C 28 provides the power that feeds both the HEADPHONE jack on the front panel and the LINE OUTPUT jacks on the rear panel. If you choose to listen to headphones only it is not necessary to operate the power amplifiers that feed the loudspeakers

To turn the power amplifiers off use the switch on the top panel of the C28 marked POWER AMPLIFIER. This switch controls the AC to the green POWER AMP receptacles on the back panel. With this switch in the OFF position nothing will be heard from the speakers.

Specifications

FREQUENCY RESPONSE:

+0, -0.5 dB 20 Hz to 20,000 Hz.

DISTORTION

Less than 0.1% at rated output level, 20 Hz to 20,000 Hz.

INPUT SENSITIVITY AND IMPEDANCE:

Auxiliary, Tuner, Tape 1, Tape 2 0.25 volts at 250,000 ohms.

Phono 1 and Phono 2 2 millivolts at 47,000 ohms (1,000 Hz).

Microphone 2.5 millivolts at 500,000 ohms.

Tape Head 2 millivolts at 500,000 ohms (500 Hz).

HUM AND NOISE

Auxiliary, Tuner, Tape 1, and Tape 2 90 dB below rated output.

Phono 1, Phono 2 and Tape Head 78 dB below 10 millivolts input, equivalent to less than 1.2 microvolts at the input terminals.

Microphone less than 1.5 microvolts at the input terminals.

OUTPUT LEVEL AND IMPEDANCE:

Main Output 2.5 volts with rated input, less than 100 ohms source impedance, to operate into 47,000 ohms or greater.

Tape Output 0.25 volts with rated input, less than 150 ohms source impedance, to operate into 47,000 ohms or greater.

Headphone/Line Output maximum 0.75 volts into 8 ohm load or 2.5 volts into 600 ohm line, less than 0.2 ohm source impedance, level controls provided.

Center Channel Output 1.25 volts with rated input to both channels, to operate into 47,000 ohms or greater, level control provided.

VOLTAGE AMPLIFICATION IN DECIBELS:

Auxiliary, Tuner, Tape 1 and Tape 2

to Main Output 20 dB

to Tape Output 0 dB

to Headphone/Line Output 17.5 dB

Phono 1 and Phono 2 at 1 kHz

to Main Output 62 dB

to Tape Output 42 dB

To Headphone/Line Output 59.5 dB

Microphone

to Main Output 60 dB

to Tape Output 40dB

to Headphone/Line Output 57.5 dB

Tape Head at 500 Hz

to Main Output 64 dB

to Tape Output 44 dB

to Headphone/Line Output 61.5 dB

POWER REQUIREMENT:

117 volts, 50/60 Hz, 45 watts.

FACILITIES & FEATURES

BASS CONTROLS:

Separate 11 position rotary switches for each channel, +20 dB to -20 dB at 20 Hz.

TREBLE CONTROLS:

Separate 11 position rotary switches for each channel, +18 dB to -18 dB at 20 kHz.

COMPENSATION SWITCH:

Three position switch for Flat, Loudness, or Presence. Loudness position boosts low frequencies for low level listening. Presence position boosts mid frequencies 4 dB to increase "presence" effect. This control operates as a function of volume control position so full compensation is obtained at lower volume levels and flat response is obtained at full volume.

BALANCE CONTROL:

Natural balance at center position, attenuation of left or right channel by rotating control.

VOLUME CONTROL:

Precision "tracked" at all listening levels. (0 to -65 db). Does not change stereo balance as loudness is changed. The power ON/OFF switch is coupled with this control.

INPUT SELECTOR:

Six positions Auxiliary, Tuner, Phono 1, Phono 2, Microphone, and Tape Head.

MODE SELECTOR:

Seven positions Left channel only to both speakers, Right

channel only to both speakers, Stereo Reverse, Stereo, Mono, L + R to left speaker only, and L + R to right speaker only.

TAPE MONITOR SWITCHES:

Two push button switches. Either of two tape recorder can be monitored by selecting the TAPE 1 push button or TAPE 2 push button. They are mechanically interlocked to accept only one pushbutton at the IN position at one time.

TAPE COPY SWITCH:

Two push button switches. Either of two tape recorders can be connected to copy from tape machine 1 to tape machine 2 or vice versa. They are mechanically interlocked to accept only one pushbutton at the IN position at one time.

LF FILTER SWITCH (Rumble Filter):

Flat or roll-off 12 dB per octave below 50 Hz, down to 18 dB at 20 Hz.

HF FILTER SWITCH (Scratch Filter):

Flat or roll-off 12 dB per octave above 7 kHz, down 18 dB at 20 kHz.

SPEAKER SWITCHES: (Operates with accessory speaker control relay)

Main Switch the MAIN loudspeaker system ON or OFF without affecting the performance of REMOTE speakers.

Remote Switch the REMOTE loudspeaker system ON or OFF without affecting the performance of MAIN speakers.

FRONT PANEL TAPE JACKS:

Allows connection to input and output of a tape recorder from the front panel of the C 28. Inserting plugs into their jacks disconnects the TAPE 2 circuits from the rear panel of the C 28 and uses the TAPE 2 facilities for the front panel jacks.

HEADPHONE JACK:

For listening with either low or high impedance stereo headphones. Power to this jack is supplied by an amplifier provided in the C 28. Headphone listening can be accomplished without the use of an external power amplifier.

SECONDARY CONTROLS:

The following controls are located behind the front panel on top of the C 28 chassis. These controls are readily accessible

by depressing the PANLOC buttons and sliding the C 28 forward from the mounting panel.

LOW FREQUENCY TRIM CONTROLS

Permits the increase in output of frequencies below 100 Hz of up to 6 dB to compensate for unequal speaker response or the unequal influence of room acoustics.

PHONO 1 AND PHONO 2 LEVEL CONTROLS

Permits variations in the phono input sensitivity of up to 10 dB. Provides for optimum signal to noise ratio and proper balance of the channels of the phono cartridge.

OUTPUT LEVEL CONTROLS

Permits the balance of the entire system to be conveniently preset.

HEADPHONE LEVEL CONTROLS

Adjusts the level and balance of the headphone/line output.

POWER AMPLIFIER ON-OFF SWITCH:

Controls power to the green 117 volt Power Amplifier receptacles. Allows the power amplifiers to be turned off when not needed for headphone listening, etc.

TRANSISTOR COMPLEMENT:

26 silicon-planar transistors, 4 silicon diodes, 2 silicon bridge rectifiers.

MECHANICAL SPECIFICATIONS

SIZE:

Front panel measures 16 inches wide by 5-7/16 inches high. Chassis measures 15 inches wide by 5 inches high by 13 inches deep including PANLOC mounting brackets and back panel connectors. Knob clearance required is 1½ inches in front of the mounting panel.

FINISH:

Front panel is anodized gold and black with special McIntosh gold/teal panel nomenclature illumination. Chassis is black.

MOUNTING:

Exclusive McIntosh developed professional PANLOC.

WEIGHT:

25 pounds net, 35 pounds in shipping carton.

Performance Charts

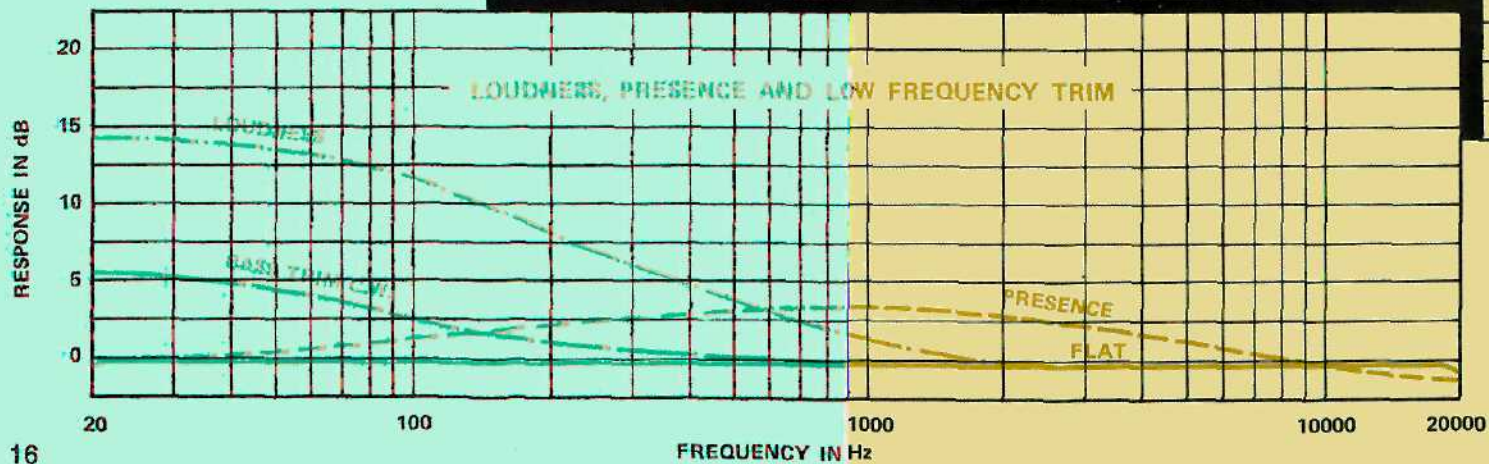
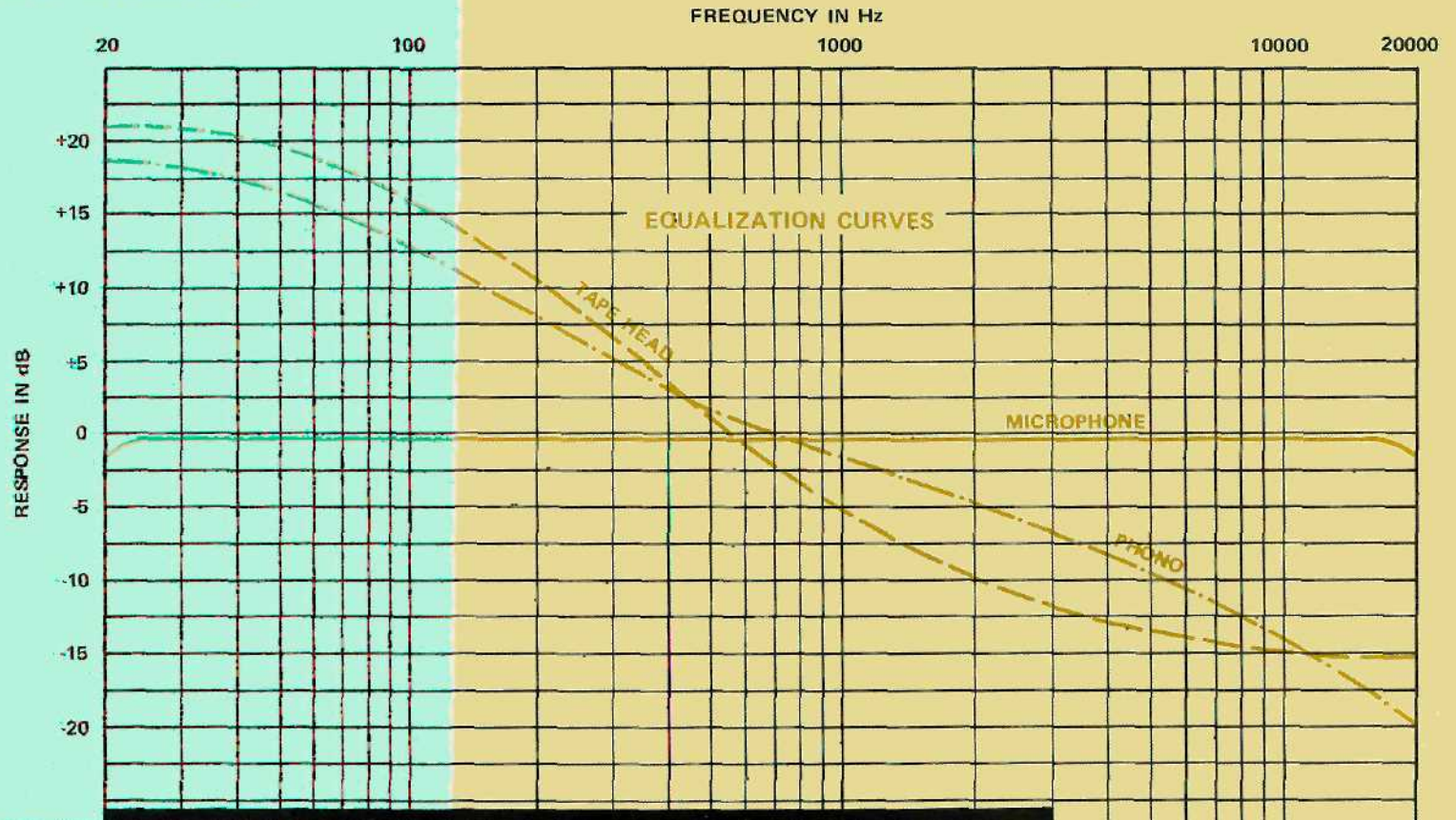

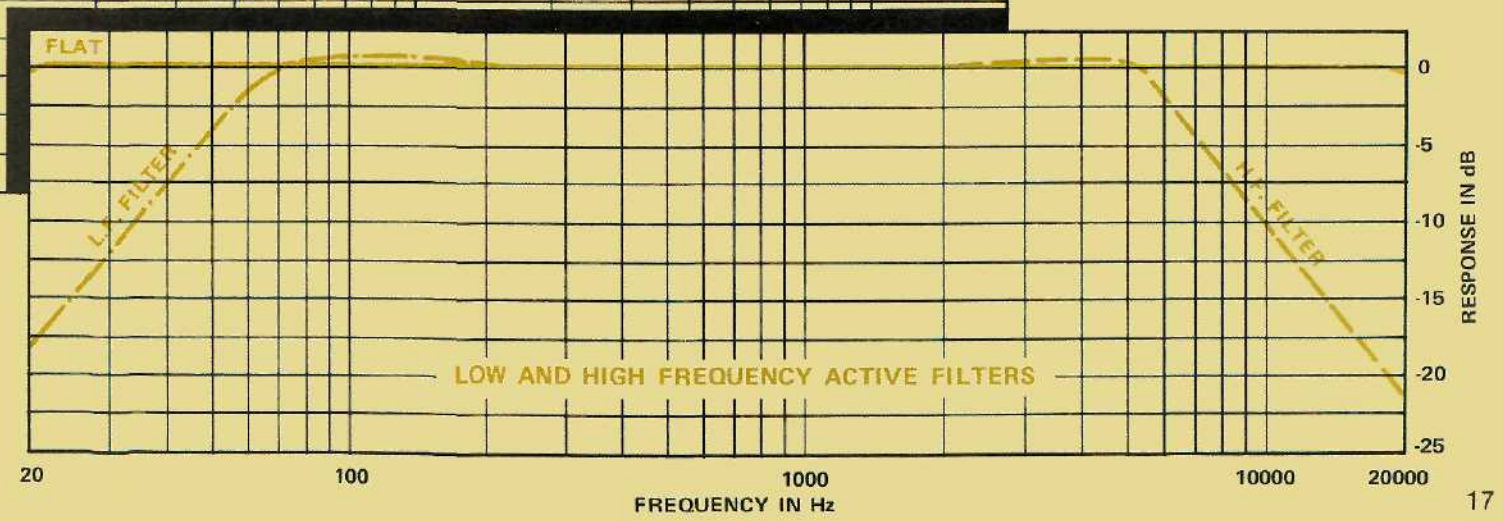
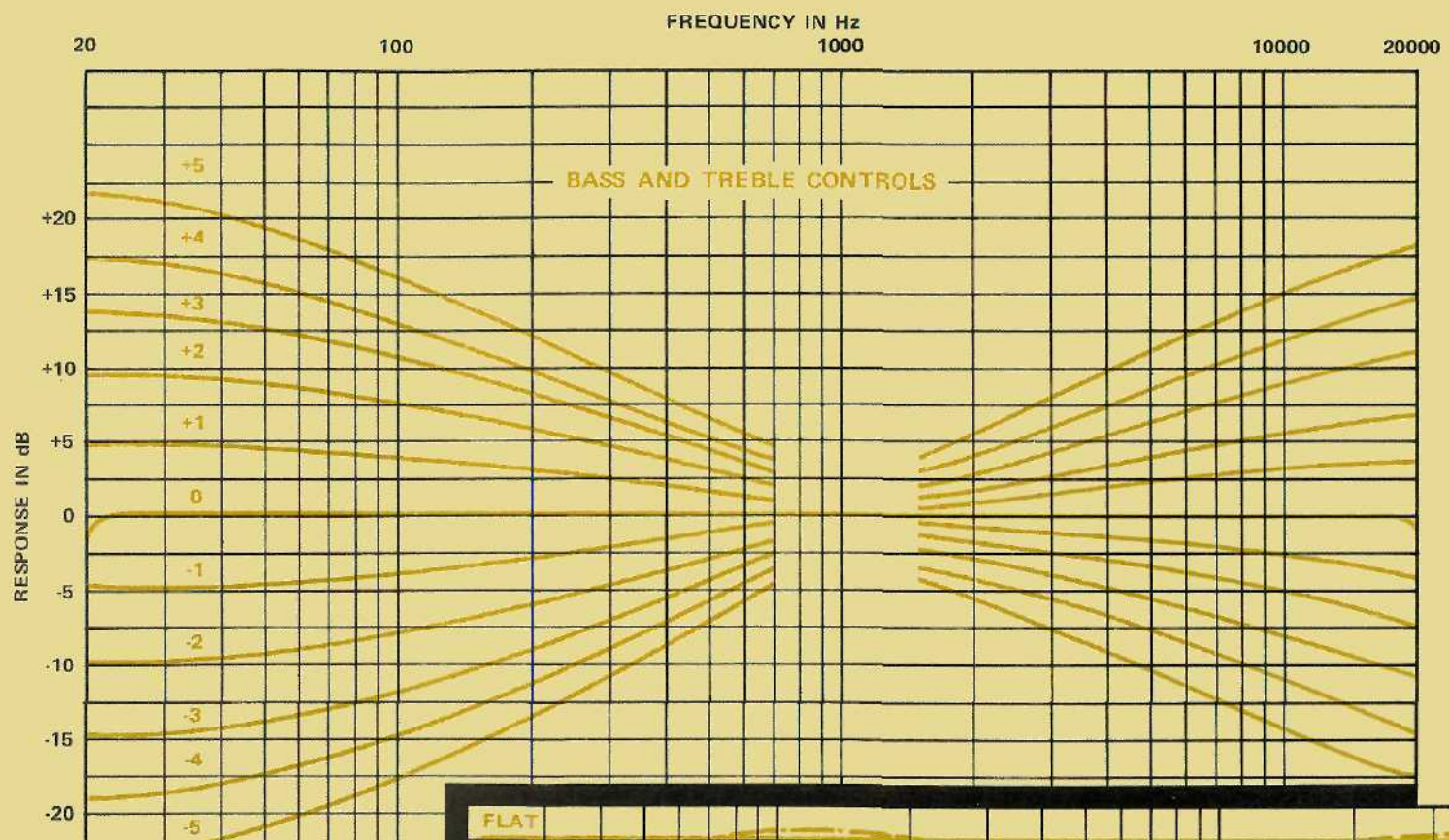

Technical Description



Basically, each channel of your C 28 consists of four main parts: low level amplifier, high level amplifier, active filters and headphone amplifier. Common regulated power supplies furnish power to both channels.

LOW LEVEL AMPLIFIER

Each channel of the low level amplifier is a four transistor differential amplifier input circuit. Precise equalization is maintained by the use of negative feedback and appropriate components specially designed for low noise. Particular attention has been exercised in the use of transistors having exceptional low noise characteristics. The differential amplifier stage is the basis for the high open-loop gain of this portion of the circuit. With a higher open-loop gain there is ample negative feedback available under all equalization conditions to ensure an extremely low level of harmonic distortion. Because equalization has been designed for minimum error the response from both tape and records is accurate.

One of the important features of this section is the use of set level potentiometers in the phono circuit. The gain of the phono preamplifier stages can be adjusted from 32 dB to 42 dB to correspond to the sensitivity of your phono cartridge.

The phono set level controls in your C 28 are designed into the negative feedback loop. They are not potentiometers at the input or output of the low level amplifier. This important design consideration allows the gain to be reduced from 42 dB to 32 dB without adversely affecting the noise level. Because the control is in the feedback loop the level of noise and distortion is reduced 10 dB but the maximum input voltage that this section can handle is increased by 10 dB. With 42 dB of gain in the phono section the maximum input voltage that the low level amplifier can accept without overloading is 150 mV at 1 kHz. When the gain is reduced to 32 dB this section can accept over 0.5 volt without overloading at 1 kHz.

HIGH LEVEL AMPLIFIER

The linear high level amplifier has a gain of 20 dB. The same careful design considerations apply with respect to noise and the reduction in non-linear distortion. Each channel of the high level

amplifier consists of 3 transistors selected for low noise characteristics. In the feedback loop, two 11 position switches allow up to 20 dB of boost or cut at 20 Hz and up to 18 dB of boost or cut at 20 kHz. At the input of the high level amplifier are the bass trim control and the switch which selects loudness or presence compensation.

The output noise level of the C 28 is below 40uV. This measurement is made with the trim controls in the flat position. 40 μ V represents a phenomenal dynamic range of 114 dB.

FILTER AMPLIFIER

The filter amplifier serves three functions: (1) a high frequency filter, (2) a low frequency filter, and (3) a 20 kHz low pass filter.

Each channel of the filter amplifier has two transistors connected in compound emitter follower configuration. The resistive and capacitive elements form a 12 dB per octave active RC filter. The high frequency filter is a 7 kHz active, low pass, filter. The low frequency filter is a 50 Hz active, high pass, filter. The filter amplifier also forms a 20 kHz active low pass filter to reduce noise outside the useful sound spectrum while leaving the preamplifier response flat to 20 kHz. A 20 kHz active, low pass, filter is connected at all times to reduce wideband noise yet maintaining flat frequency response up to 20 kHz.

The non-linear distortion of these active filters is very low even at cut off frequency. This is not the case in passive filters where a very low impedance at the cut off frequency is presented to the driving source. This low impedance will cause high non-linear distortion at and near the cut off frequency. The design of the C 28 eliminates this problem.

HEADPHONE AMPLIFIER

The headphone amplifier is capable of producing 0.75 volts of output into 8 ohm headphones with less than 0.1% harmonic distortion. This is adequate power to drive any dynamic type headphone.

The maximum output of the headphone amplifier is 2.5 volts into 50 ohms or greater at the LINE OUTPUT terminals on the rear panel. The internal impedance of the headphone amplifier is less

than 0.2 ohms. Long shielded cables can be used without adversely affecting the frequency response. The headphone level controls adjust the output level and balance of the headphone amplifier.

POWER SUPPLY

The power supply consists of a low impedance 75 volt power supply and a 14 volt power supply for the headphone amplifier. The 75 volt supply is stabilized by a series regulator transistor and a zener diode. An accessory filter chain and voltage dividing network provides 18 volts to the low level circuits.

The headphone amplifier is powered by a separate 14 volt supply which uses a transistor as an effective ripple filter.

A principle design consideration was exceptionally low hum level. First the power transformer of the C 28 uses a magnetic core with very low flux density. Double shielding has been accomplished by surrounding the transformer first with strips of copper, and then with strips of treated soft iron. The shielded transformer is potted in a heavy gage soft steel can. To prevent unbalance of the magnetic flux of the transformer, the secondary voltage is rectified by silicon diodes in a bridge configuration.



Block Diagram

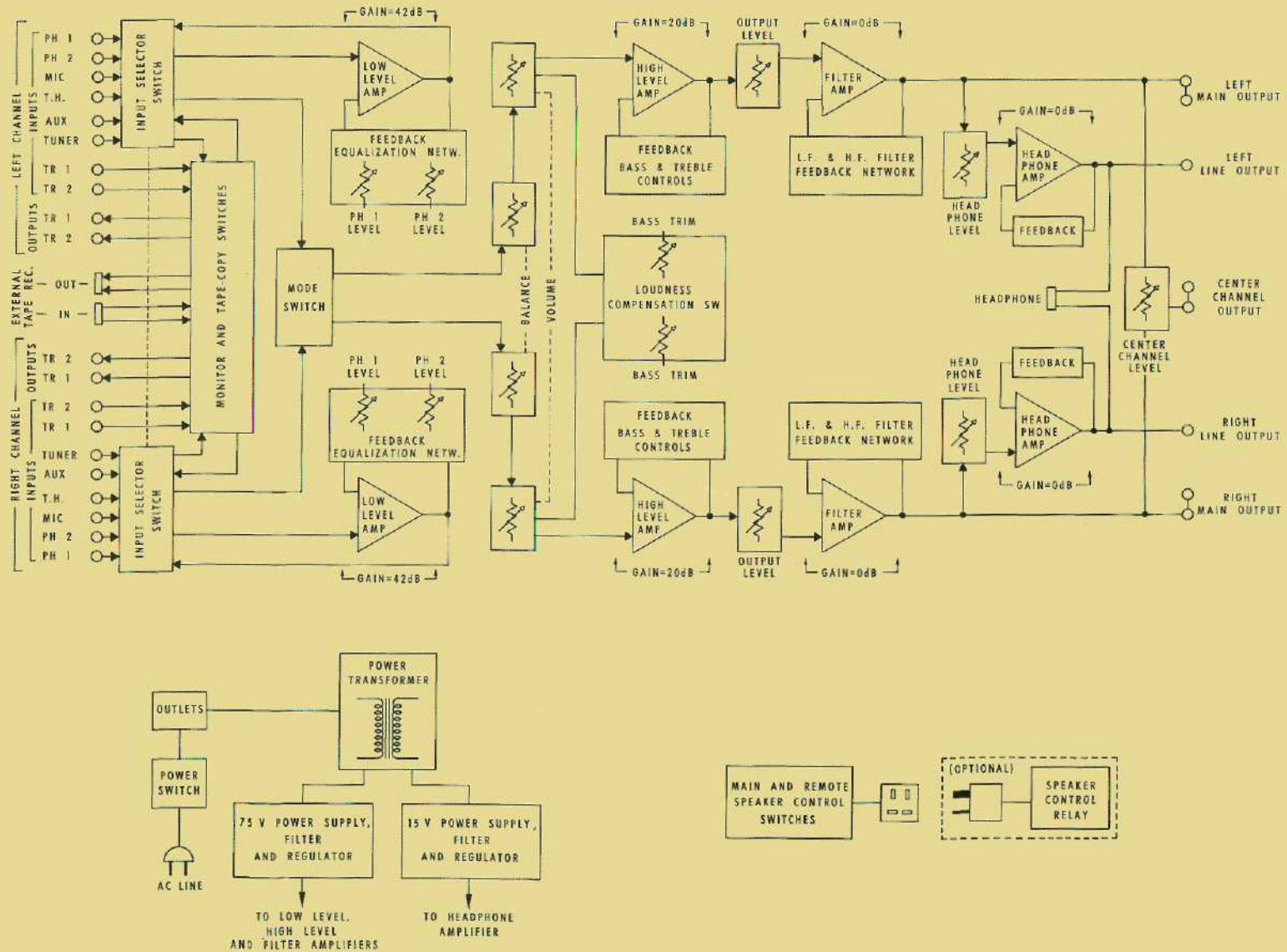

McIntosh

McINTOSH LABORATORY INC.

2 CHAMBERS ST., BINGHAMTON, N. Y. 13903

607-723-3512

Design subject to change without notice.

Printed in U.S.A.